











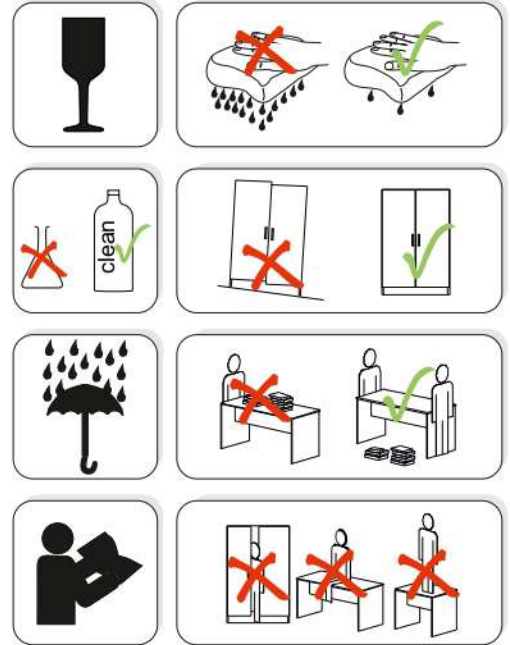
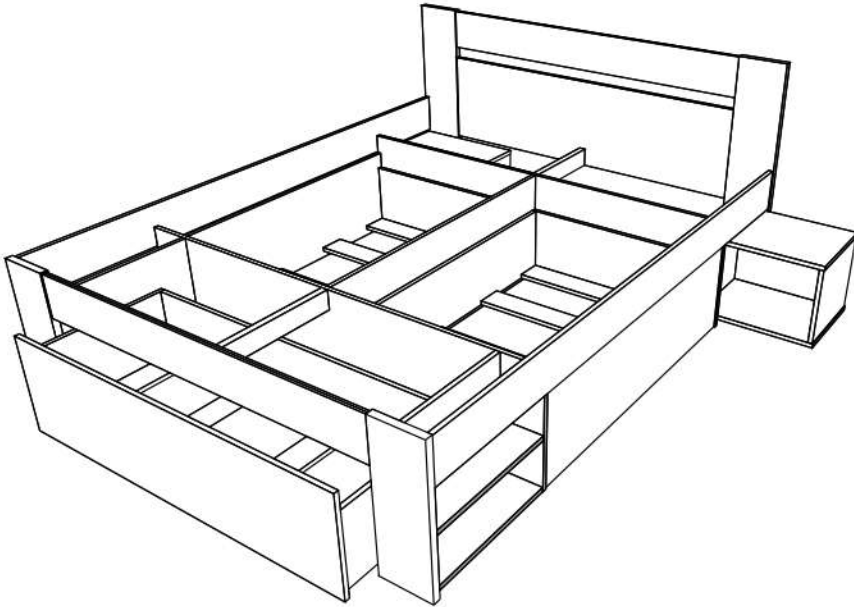

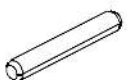

REA KIRA 180

 1860
 900
 2050



1/3 korpus

| | | | | | | | | | | | | | |
|------|---|---|---|---|---|---|---|---|--|------|---|---|---|
| 1 |  | 2 |  | 3 |  | 4 |  | 5 |  | 6 |  | 7 |  |
| 8x35 | 46 x | | 24 x | | 44 x | | 20 x | | 10 x | 8x60 | 14 x | | 12 x |

| | | | | | | | |
|--------|---|--------|---|----|---|----|---|
| 8 |  | 11 |  | 14 |  | 15 |  |
| 1,2x25 | 24 x | 3,5x16 | 12 x | | 6 x | | 4 x |

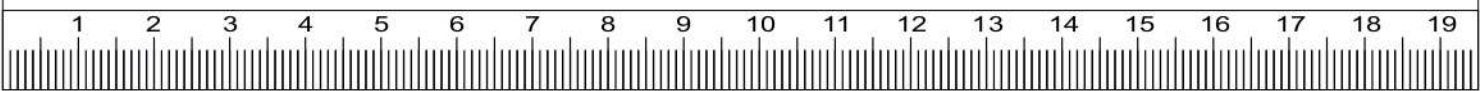
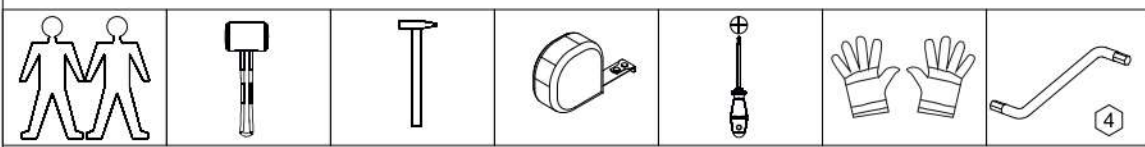

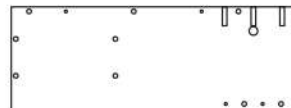
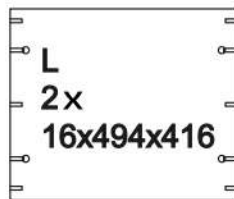
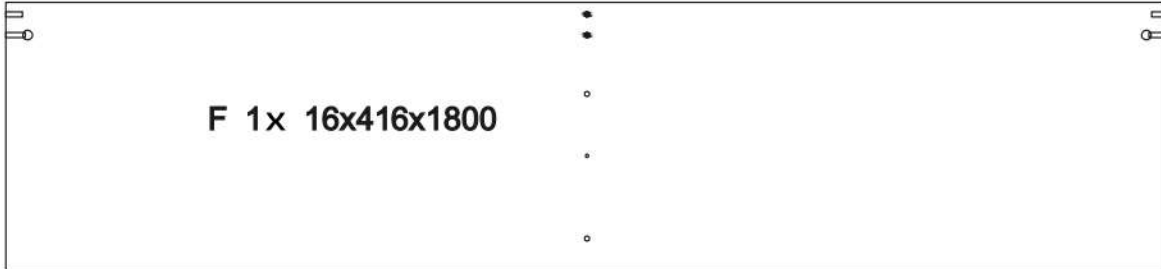
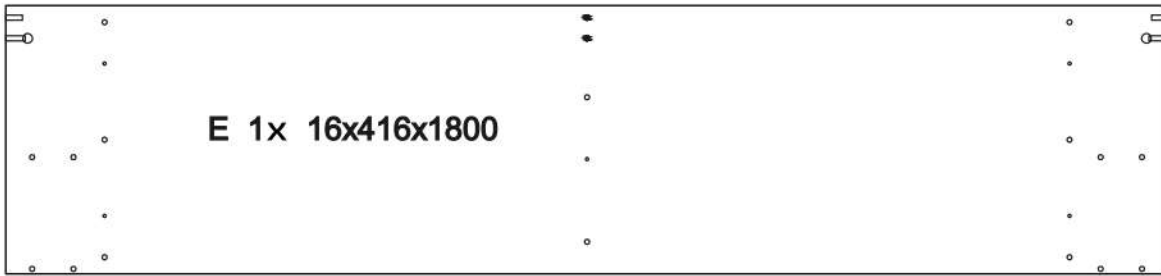
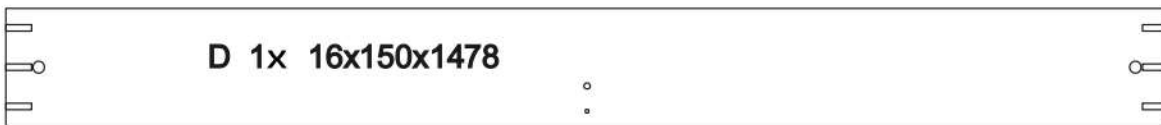
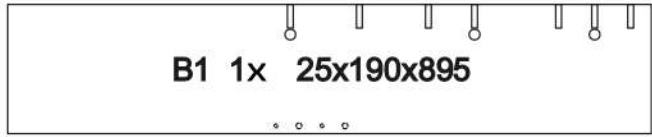
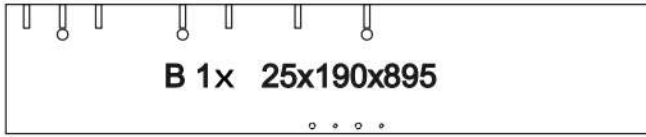
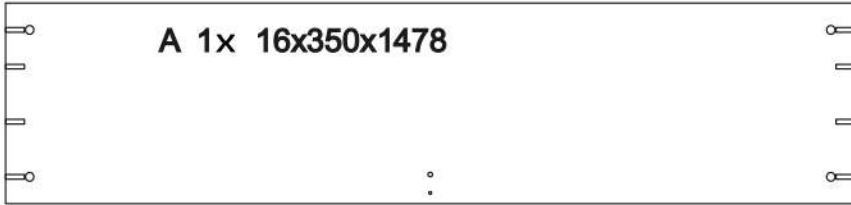

1

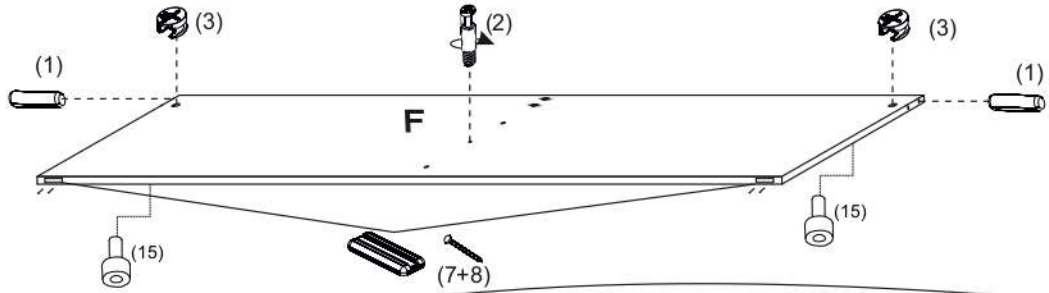

2

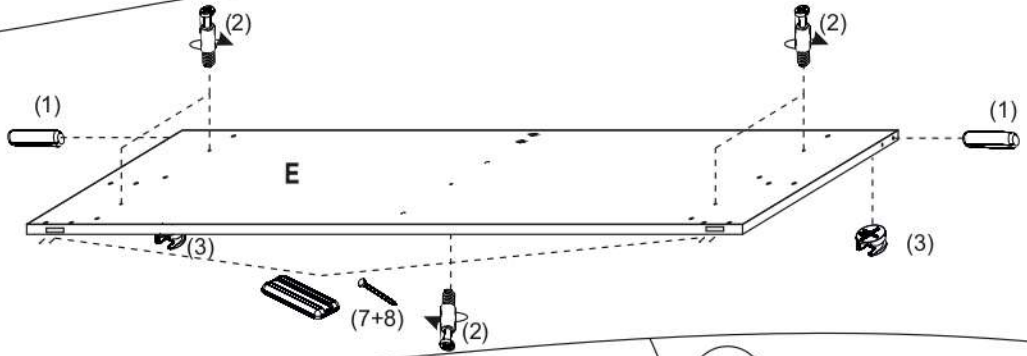

3

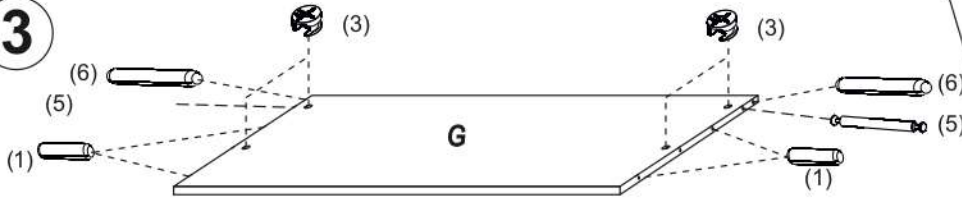

4

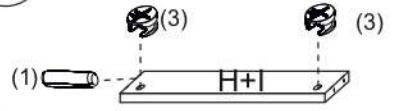

5



6

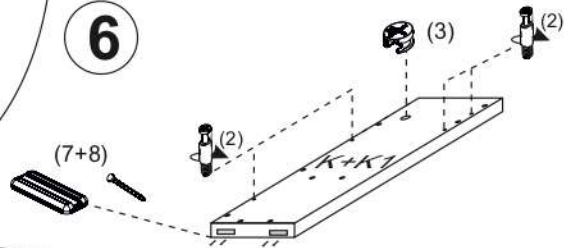

7

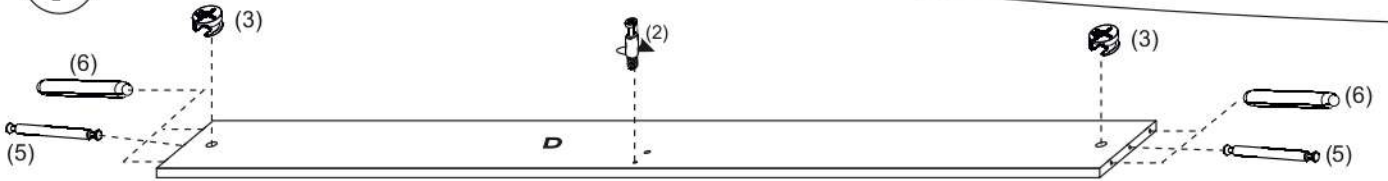



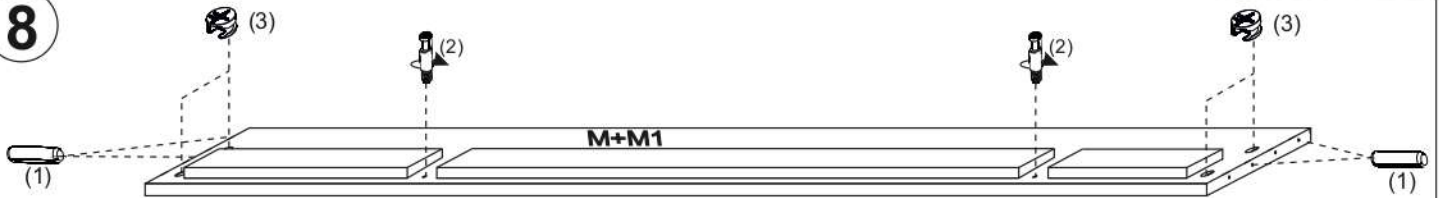

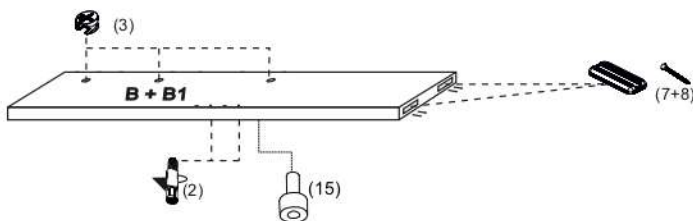

8

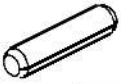

9







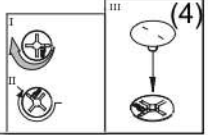
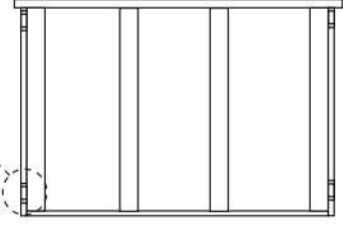
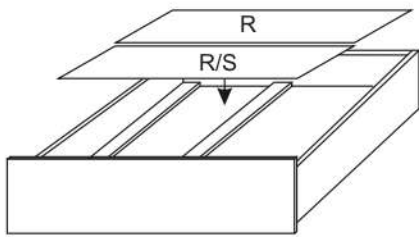
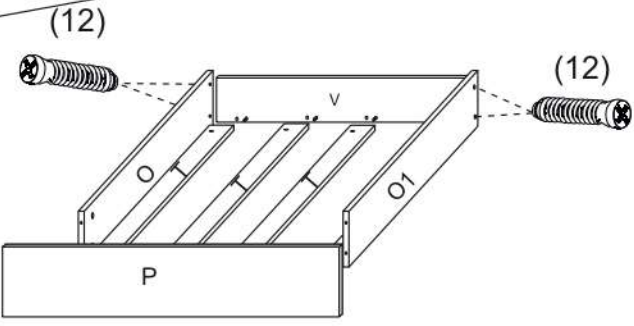
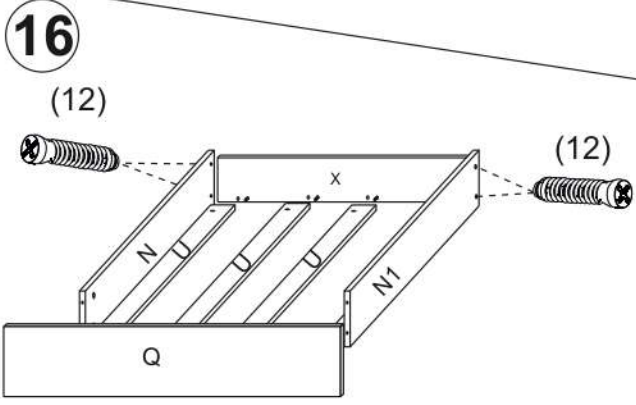
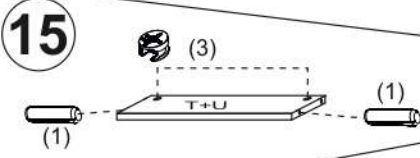
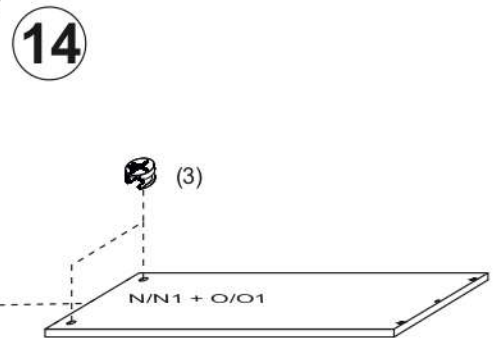
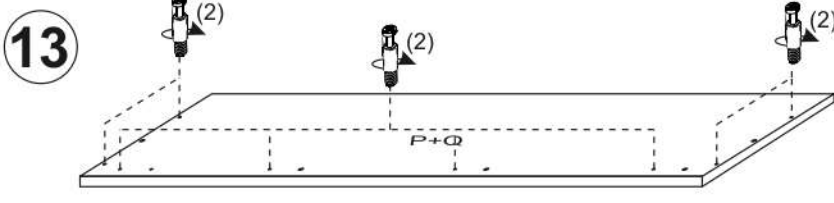
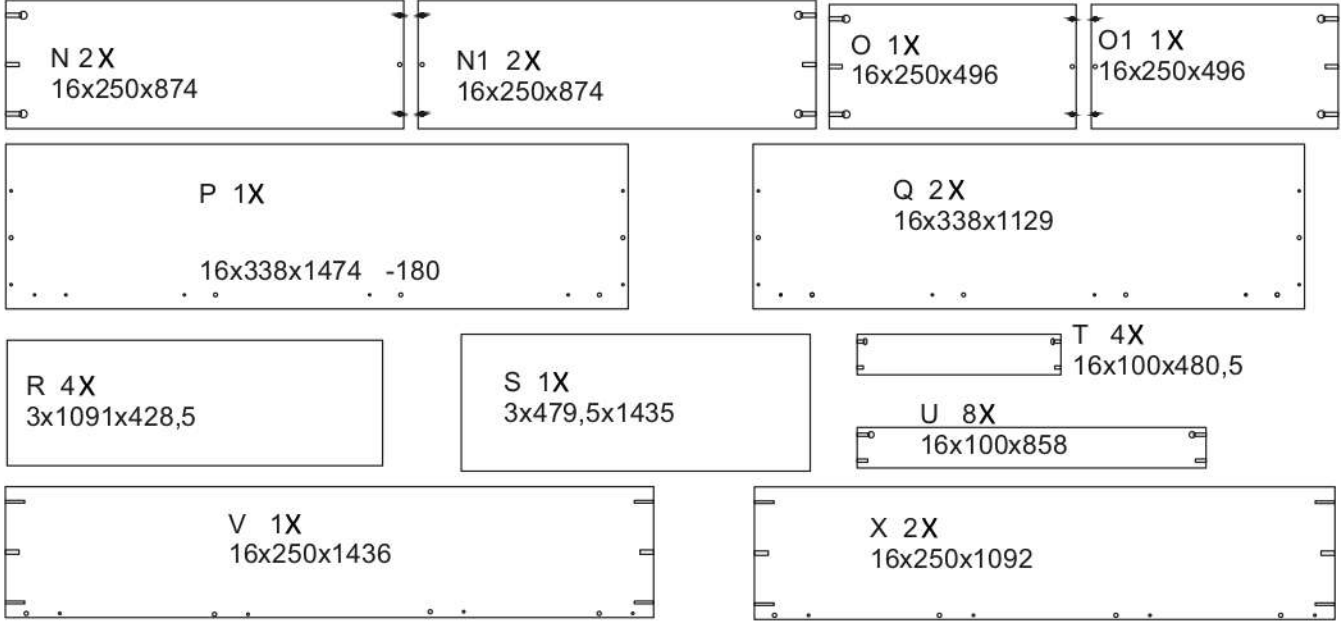

2/3 predali

| | | | | | | | | | | | | | |
|------|---|---|---|---|---|---|---|---|--|------|---|------|---|
| 1 |  | 2 |  | 3 |  | 4 |  | 9 |  | 10 |  | 12 |  |
| 8x35 | 34X | | 36X | | 36X | | 12X | | 12X | 3x20 | 24X | 7x50 | 12X |



3/3 nočna omarica

| | | | | | | | | | | | |
|------|---|---|---|---|---|---|---|---|--|--------|---|
| 1 |  | 2 |  | 3 |  | 4 |  | 9 |  | 11 |  |
| 8x35 | 16X | | 16X | | 16X | | 16X | | 8X | 3,5x16 | 16X |

